



# RAJASTHAN STATE MINES & MINERALS LIMITED

(A Government of Rajasthan Enterprises)

CIN No.: U14109RJ1949SGC000505

PAN No : AAACR7857H

GSTIN No. 08AAACR7857H1Z0

<b>REGISTERED OFFICE:</b> C89-90, Lal Kothi Scheme, Janpath Jaipur, Rajasthan Ph.:+91-141-2743734, 2743934 Fax: +91-141-2743735, 2428739	<b>CORPORATE OFFICE:</b> 4, Meera Marg, Udaipur - 313 001 Ph.: -91-294-2428768, 2428763- 67 Fax:+91-294-2428768	<b>SBU-PC Rock Phosphate</b> Jhamarkotra-313015 Purchase Department, Phone: 0294-2324441-43 Telefax: 0294-2342444
Website : <a href="http://www.rsmm.com">www.rsmm.com</a> email: <a href="mailto:satishkachhawa.rsmml@rajasthan.gov.in">satishkachhawa.rsmml@rajasthan.gov.in</a>		

## TENDER DOCUMENT

TO

**e\_TENDER NO. NIT-29/20-21 Dated 04-02-2021**

**FOR SUPPLY OF**

**“Fabricated Nature of Spares”**

S.N.	Description	Date	Time
1	<b>Bid Submission Start Date</b>	04-02-2021	10.00 a.m.
2	<b>Bid Submission Closing date</b>	04-02-2021	6.00 p.m.
3	<b>Techno-Commercial Bid Opening Date</b>	24-02-2021	3.30 p.m.
4	<b>Submission Demand Draft / Bankers cheque/ Bank Pay Orders of Tender Document Fee, Processing Fees and Bid Security</b>	22-02-2021	Up-to 6.00 p.m.
5	<b>Price Bid Opening Date</b>	Will be intimated later on to the techno-commercially qualified bidders	
6	<b>Websites for downloading tender documents/ corrigendum etc.</b>	<a href="http://www.rsmm.com">www.rsmm.com</a> , <a href="http://eproc.rajasthan.gov.in">http://eproc.rajasthan.gov.in</a> <a href="http://www.sppp.rajasthan.gov.in">www.sppp.rajasthan.gov.in</a>	
7	<b>Website for submission of tender/bid (only online)</b>	<a href="http://eproc.rajasthan.gov.in">http://eproc.rajasthan.gov.in</a>	
8	<b>Tender Document Fee</b>	<b>Rs. 1180/-</b> (Inclusive of GST) in favour of “Rajasthan State Mines & Minerals Limited” payable at Udaipur.	
9	<b>RISL Processing Fee</b>	<b>Rs.1,000/-</b> in favour of “MD RISL” payable at Jaipur	
10	<b>Bid Security</b>	<b>Rs. 18,000/-</b> in favour of “Rajasthan State Mines & Minerals Limited” payable at Udaipur	



# RAJASTHAN STATE MINES & MINERALS LIMITED

(A Government of Rajasthan Enterprises)

CIN No.: U14109RJ1949SGC000505

PAN No : AAACR7857H

GSTIN No. 08AAACR7857H1Z0

<b>REGISTERED OFFICE:</b> C89-90, Lal Kothi Scheme, Janpath Jaipur, Rajasthan Ph.:+91-141-2743734, 2743934 Fax: +91-141-2743735, 2428739	<b>CORPORATE OFFICE:</b> 4, Meera Marg, Udaipur – 313 001 Ph.: -91-294-2428768, 2428763- 67 Fax: +91-294-2428768	<b>SBU-PC Rock Phosphate</b> Jhamarkotra-313015 Purchase Department, Phone: 0294-2324441-43 Telefax: 0294-2342444
Website : <a href="http://www.rsmm.com">www.rsmm.com</a> email: <a href="mailto:satishkachhawa.rsmmml@rajasthan.gov.in">satishkachhawa.rsmmml@rajasthan.gov.in</a>		

## **e-TENDER NO. 29/20-21 dated 04-02-2021**

### **NOTICE INVITING e-TENDER**

e- Tenders in Two parts (Techno Commercial Part & Price Part) are invited from reputed suppliers as detailed hereunder:-

Description	Bid Security (in Rs.)	Due date of opening
Fabricated Nature of Spares	18,000/-	24-02-2021 at 3.30 pm

For more details, visit us on web site [www.rsmm.com](http://www.rsmm.com), [www.eproc.rajasthan.gov.in](http://www.eproc.rajasthan.gov.in), [www.sppp.rajasthan.gov.in](http://www.sppp.rajasthan.gov.in) or contact DGM (MM), SBU-PC, Rock Phosphate, Jhamarkotra at the above address.

(Satish Kachhawa)  
Dy. General Manager (MM)



# RAJASTHAN STATE MINES & MINERALS LIMITED

(A Government of Rajasthan Enterprises)

General	Instruction for preparation & submission of tender and General Conditions of Tender
Annexure- I	Technical Specifications
Annexure- II	General profile of tenderer
Annexure- III	Undertaking towards acceptance of all terms & conditions of tender
Annexure- IV	Undertaking towards non suspension/non banning.
Annexure- V	Registration details as per Micro, Small & Medium Enterprises Development Act,2006.
Annexure- VI	Details of taxes & duties
Annexure-VII	Details of Past Experience
Annexure- VIII	Declaration about Tenderer's Status
Annexure-A	Compliance with the Code of Integrity and No Conflict of Interest.
Annexure-B	Declaration by the Bidder regarding Qualifications.
Annexure-C	Grievance Redressal during Procurement Process and Form No. 1.
Annexure-D	Additional Conditions of Contract.
Form-A	Format of Application by MSME for Purchase Preference in Procurement of Goods
Form-B	Format of Affidavit

## INSTRUCTIONS FOR PREPARATION & SUBMISSION OF E-TENDER AND CONDITIONS OF E-TENDER

### 1.0 PREPARATION & SUBMISSION OF TENDER AND CONDITIONS OF E-TENDER

- a. Tender shall be submitted online only through e-procurement portal of GoR i.e. [www.eproc.rajasthan.gov.in](http://www.eproc.rajasthan.gov.in).
- b. No physical/offline Tender/bid shall be accepted.
- c. **Bid Security and Tender Document Fee** shall be in the form of Demand Draft / Bankers Cheque drawn in favour of **“Rajasthan State Mines & Minerals Limited” payable at Udaipur** and shall be submitted to the office of the SM (F&A), Marketing Department, 4-Meera Marg, Udaipur up-to schedule date and time as above.
- d. **Processing Fee** shall be in the form of Demand Draft / Banker Cheque drawn in favour of **“MD RISL” payable at Jaipur** and shall also be submitted to the office of the SM (F&A), Marketing Department, 4-Meera Marg, Udaipur up-to schedule date and time, as above.
- e. Conditional tenders and casual letters sent by the bidders will not be accepted.
- f. Bidders are requested to read the instruction in the Tender Document/Bid before submitting the Tender/BID online.
- g. The Tender Document is not transferable.
- h. Bidders who wish to participate in this tender will have to be registered on <http://eproc.rajasthan.gov.in>. To participate in online tenders, bidders will have to procure Digital Signature Certificate (type II or III) as per Information Technology Act-2000 using which they can sign their electronic bids. Bidders can procure the same from any CCA approved certifying agency or may contact Government of Rajasthan e-procurement Cell, Department of IT&C for further assistance. Bidders who already have a valid Digital Certificate need not to procure a new Digital Certificate.
- i. Contact details of Government of Rajasthan e-procurement Cell, Department of IT&C are: Telephone No. 1800 3070 2232, 0141-4022688, 0141- 4022688 (Help Desk 10.00 AM to 6.00 PM on all working days), email: [eproc@rajasthan.gov.in](mailto:eproc@rajasthan.gov.in) Address: e-procurement cell, RISL. Yojana Bhawan, Tilak marg, C-Scheme, Jaipur.
- j. Training for the bidders on the usage of e-Tendering system is also being arranged by RISL on regular basis. Interested bidders may contact e-Procurement Cell, RISL.
- k. Bidder shall submit their offer on-line in electronic formats both for techno-commercial and financial bid, however DD/Banker Cheque for Tender Fees,

Processing Fees and Bid Security should be submitted offline (personally/post/courier) to the office of SM (F&A), Marketing Department, - Meera Marg, Udaipur before scheduled date & time as mentioned in tender document. Scanned copies of DDs/ BCs should also be uploaded along with the online Bid.

- l. Before electronically submitting the tenders, it should be ensured that all the tender papers including conditions of contract are digitally signed by the tenderer.
- m. Bidders are also advised to refer “Bidders manual” available under “Download” section for further details about the e-tendering process.
- n. All bidders are advised not to wait for last date and submit their tender/bid at earliest. The Company shall not be responsible for any interruption/technical snag in website and No extension in deposition of Tender/bid shall be allowed unless otherwise RSMML extends the dates.
- o. In compliance to the Rajasthan Transparency in Public Procurement Act, 2012 and Rajasthan Transparency in Public Procurement Rule, 2013, following annexure are enclosed and tenders are required to furnish duly filled, sealed and signed copies of these annexures along with Part-I of offer :
  - i. Annexure-A- Compliance with the Code of Integrity and No Conflict of Interest.
  - ii. Annexure-B- Declaration by the Bidder regarding Qualifications.
  - iii. Annexure-C- Grievance Redressal during Procurement Process and Form No. 1.
  - iv. Annexure-D- Additional Conditions of Contract.
- p. **Bidders shall have to furnish the legible/readable bid documents in the “covers” as prescribed in the document in PDF/jpg format. All the documents should be sealed & signed by the tenderer.**

#### **COVER-A**

- Scanned Copies of DDs/BCs towards Tender Document Fees, Bid Security and Processing Fees.
- Authorization certificate in favour of the authorised representative of bidder for signing the tender
- Sealed and signed copy of tender document towards acceptance of terms and conditions.
- General profile of tenderer as per annexure-II, undertaking towards acceptance of all terms & conditions of tender as per annexure- III, Declaration towards banning/suspensions as per annex- IV.
- Registration details as per MSME Act, 2006 as annexure- V along with supporting documents.
- Details of taxes & duties offered in price bid as per annexure-VI.

#### **COVER-B**

- Checklist to technical specification for the tendered product as per annexure-I.
- Details of Past Experience as per annexure-VII
- Declaration of tenderer as per annexure -VIII

#### **COVER-C**

- Price Bid in **xls format**.

### **2.0 SUBMISSION & OPENING OF TENDERS.**

The online submission of bids on the e-procurement portal i.e. <http://eproc.rajasthan.gov.in> within the specified date and time will be the sole responsibility of the Tenderers. In case the date of opening of bids happens to be a holiday, then the bids shall be opened on the next working day.

Tenderers are requested to ensure submitting their tender online on e-procurement portal only and furnishing DDs/BCs towards tender document fee/Bid Security/ Processing Fees offline to the office of SM(F&A), Marketing Department, CO within the specified time & date of submission. Tenders in physical form (offline) will not be acceptable in any case.

Tenderers should note that they will not be able to submit their tenders online after the specified/ scheduled date & time of submission of bid document. Tenderers should also ensure furnishing DDs/BCs towards tender document fee/Bid Security/Processing Fees to the office of SM(F&A), Marketing Department, CO within the specified time & date of submission, failing which, their online bids will not be opened.

### **3.0 EXCEPTION & DEVIATION/ ACCEPTANCE OF ALL THE TERMS & CONDITION OF TENDER:**

Tenderers are advised to submit their offer based on terms & conditions and specifications contained in the tender document and not to stipulate any deviations.

- a. Offer containing stipulations of deviations to the terms & conditions are liable to be ignored. However, in case it is absolutely unavoidable to deviate from tender conditions then the tenderers should mention the deviations at their risk of rejection only in Annexure- I.
- b. Deviations mentioned anywhere else in the offer shall be ignored without any consequences.
- c. Tenders containing corrections and alterations are liable to be rejected unless all such corrections and alterations are legible, clear and signed by the tenderer.

### **4.0 SPECIFICATION, QUANTITY & SCOPE OF SUPPLY:**

- a. Quantity & detail technical specifications are as per annexure-I
- b. The scope of supply shall be the delivery of Stores by the supplier as per Annexure-I in accordance with the Terms and Conditions of the Tender.
- c. The supplier shall be deemed to have carefully examined and to have knowledge of the general and other conditions, schedules, and all other documents forming part of the contract, and also to have satisfied himself as to the nature and character of the Stores to be delivered under the contract.
- d. The supplier shall be entirely responsible for the performance of the contract in all respects according to the intent and meaning of the specification data.

### **5.0 QUALITY OF SPARES & STANDARD APPLICABLE WARRANTY:**

- a. Tenderer shall warrant that the spares supplied under the contract/order will be new, unused and shall be free from all defects and faults in material & workmanship.
- b. The spares will be consistent with the established, recognized or stipulated standards for materials of the type ordered and in full conformity with the specifications, drawings or samples, if any.
- c. The supplier shall guarantee/warranty for the satisfactory performance of the spares for a minimum period 12 months from the date of supply of material at our site. This warranty shall survive inspection and acceptance of the goods.
- d. In the event of any defect in material, design and workmanship during the aforesaid period is found due to faulty material, design or poor workmanship, the defective part will be repaired/ replaced by the supplier at site free of cost within 30 days from the date of issue of letter (by registered/speed post) of warranty claims. The tenderer will be required to stock spare parts to take care of warranty failures. The guarantee/composite warranty shall be submitted along with the bill. Tenderer will also replace the defective parts, if any, during the warranty period free of cost. The responsibility to collect the defective/ rejected material will lie with the supplier and the cost for such collection will have to be borne by the supplier.
- e. In case, supplier fails to repair/replace the failed parts within the stipulated period as above, RSMML shall be entitled to recover from the supplier as agreed pre-determined compensation @ 1/2% (Half percent) per week of the total value of undelivered stores for each week or part thereof the delivery has been delayed, subject to a maximum of 5% of the total value of the undelivered stores.

### **6.0 DELIVERY TERMS:**

The delivery basis of the stores will be on f.o.r. destination basis at SBU-PC (RP), Jhamarkotra Mines, via Udaipur. The Tenderer should state the earliest delivery period they can offer for full or part quantity.

### **7.0 VALIDITY:**

The tenderer shall keep the offer open for acceptance by RSMML for a minimum period of **Four Months** from the date of opening of tender (Part-I), within which period the tenderer shall have no right to withdraw, cancel, amend or modify his offer. In case of withdrawal/cancellation/ amendment/ modification in the offered tender, the Bid Security deposited by the tenderer shall stand forfeited. The validity period may be extended further, if required, by mutual consent from time to time.

In case, tenderer, after issuance of communication of acceptance of offer (LOA/PO) by RSMML, fails to execute the contract as per the conditions therein, such an event will be considered as the tenderer's calculated willful breach of the contract. The cost & consequence in such cases shall be on the sole account of the tenderer. Moreover, RSMML have full right to claim damages thereof in addition to the forfeiture of BID SECURITY.

#### **8.0 BID SECURITY, TENDER DOCUMENT FEES & PROCESSING FEES:**

- a. The tenderer shall deposit interest free Bid Security of Rs. 18,000/- by Demand Draft/Banker's Pay order. Further, tenderers shall deposit (interest free) a sum Rs. 1,180/- (inclusive of GST) as tender document fees and Rs. 1000/- as processing fees by PO/Demand Draft only to the office of SM(F&A), Marketing Department, CO, Udaipur within the specified date & time. The details of furnishing such financial instruments are elaborated in clause no. 1.0. Payments through Cash, Cheque or Bank Guarantee will not be accepted.
- b. DD/Banker Cheque for Tender Fees, Processing Fees and Bid Security should be submitted offline (personally/post/courier) to the office of SM(F&A), Marketing Department, CO, Udaipur before scheduled date & time as mentioned in tender document. Scanned copies of DDs/ BCs should also be uploaded along with the online Bid. The tender document fees & processing fees are non-refundable.
- c. The Bid Security shall be forfeited in case of:
  - If tenderer unsolicited revises and/or modifies and/or withdraw &/or cancel/amend the offer at its own after submission of tender during the validity period.
  - If it is established that tenderer has submitted any wrong information/forged document alongwith the tender or thereafter.
  - If the tenderer declines to accept contract/order placed by the Company subsequent to acceptance of his offer.
  - If the tenderer does not submit the security deposit cum performance guarantee.
  - If the tenderer breaches any provisions of code of integrity prescribed for bidders as specified at Annexure-A.
- d. The Bid Security furnished by the unsuccessful tenderers will be refunded after finalization of tender / validity of the offer has expired. Bid Security of successful tenderer will be refunded after receipt of Security Deposit cum performance guarantee.
- e. The Bid Security of a tenderer lying with the company in respect of other tenders awaiting approval or rejected or on account of contract completed will not be adjusted towards Bid Security deposit against this tender, however, the Bid Security originally deposited may be taken into consideration in case tender is re-invited. However, tender document fees and processing fees have to be furnished afresh in case of re-tender.

#### **9.0 SECURITY DEPOSIT CUM PERFORMANCE GUARANTEE:**

- a. As security for the due, proper and faithful fulfillment of the obligations under the contract, the tenderer will furnish to RSMML, Security Deposit cum Performance Guarantee equal to 5 % of the total estimated value of the contract by way of Demand Draft/ pay order or in the form of Bank Guarantee in RSMML Performa from any Public Sector/HDFC/ICICI/AXIS Bank (except the State Bank of India) having its branch at Udaipur, within 21 days from the date of award of LOA/PO. The Bank Guarantee should be valid for a period of 18 months (inclusive of 3 months claim period) from the date of supply of material at our site.
- b. The BG shall liable to be invoked/ amount of SD is liable to be forfeited wholly or partly at the sole discretion of the Company, should the tenderer either fails

- to execute the work within the stipulated period or fails to fulfill the agreed obligations or fails to settle in full, it's dues to the Company.
- c. The Company is empowered to recover any sum due and /or any other sum that may be fixed by the Company as being the amount or loss or losses or damages suffered by it due to unsatisfactorily performance or non fulfillment of any of the conditions of the tender/contract from the S.D.
  - d. The Bank Guarantee/ S.D. shall remain in force and binding, notwithstanding, if any variation, alternation, modifications are made to the contract or any extension of the contract period is granted by RSMML.
  - e. RSMML shall not pay any interest on the Security Deposit. The security Deposit shall be released on application by the contractor after the expiry of guarantee and after discharge of all the tenderer's obligations under the contract.
  - f. The said Security shall not in any way be construed as a limitation of the tenderer's responsibility or liability pertaining to its obligations and guarantee under the contract and shall be without prejudice to any other remedies available to RSMML in terms of the contract and or as per the laws of the land.
  - g. In case SD is being furnished in the form of Bank Guarantee, the BG should be furnished on the non-judicial stamp paper of the value equal to 0.25 % (zero-point twenty five percent) of the total Security Deposit Amount subject to maximum of Rs. 25000/- or as applicable on the date of issue of BG
  - h. S.D. should be sent to the office of DGM (MM), SBU-PC, Jhamarkotra.

#### **10.0 RELAXATION IN TENDER DOCUMENT FEES, BID SECURITY & SECURITY DEPOSIT CUM PERFORMANCE GUARANTEE:**

- A.** Tenderers offering in capacity of micro, small and medium enterprises of the State of Rajasthan, having acknowledgement of Entrepreneurs Memorandum-II/Udyog Aadhaar Memorandum as mentioned in Micro, Small and Medium Enterprises Development Act, 2006, issued by the competent authority facilitated, on furnishing of a self-attested copy of acknowledgement of Entrepreneurs Memorandum-II/Udyog Aadhaar Memorandum, following relaxations will be provided-
  - a. Tender document fees will be taken @50% of the prescribed total value of Tender document fees.
  - b. Bid Security will be taken @25% of the total value of Bid Security. In case of offering the quantity lesser than the tendered quantity, then they can submit proportionate amount of bid security in proportion to the quantity being offered with respect to the bid security amount for tender quantity.
  - c. Security Deposit will be taken @1% of the total value of order.
- B.** In case of participation by Undertakings, Corporations, Autonomous Bodies which are controlled and managed by Govt., Govt. Undertakings and Companies of Union Govt. & Govt. of Rajasthan, they are exempted from deposition of Bid Security.

Except above, no exemption in respect of Tender Document Fee, Bid Security & Security Deposit (Performance Security) will be given to any party on any grounds (except considered by management on the merit of the case) and their offer will be liable for rejection.

#### **11.0 PURCHASE PREFERENCE TO MSME FIRMS:**

The purchase preference will be given to MSMEs firms of Rajasthan as per notifications issued by Finance Department, GoR. For availing the purchase preference, bidder has to furnish declaration/certificate as per Form-A & B annexed.

#### **12.0 SHORT LISTING OF TENDERER:**

RSMML will short list the tenderer for price bid opening on the basis of documents furnished along with Part -I of the offer and/or the information gathered by the RSMML about the tenderer. The price bid of only short-listed tenderer(s) will be opened on a later date, which will be informed to such tenderer(s) only. The decision of the Company shall be final and binding in this regard.

The tenderer who have earlier been suspended or banned by the company shall not be eligible to to participate in this tender during the currency of suspension/ban period.

**13.0 DETERMINATION OF LOWEST BIDDER FOR EVALUATION PURPOSE:**

- a. For evaluation purpose, the lowest tenderer shall be determined separately for each item on the basis of total landed cost of the material at destination inclusive of all duties, taxes, transportation charges etc and giving effect of any other duties/taxes levied/ exempted except GST by the State/Central Govt. which are applicable directly / indirectly on the supply. On similar basis L2, L3, L4,..... Tenderers will be determined.
- b. In case RSMML opt for placing the purchase order to more than one tenderer, then initially L2 tenderer will be extended opportunity to match L1 rate after giving effect, as above on refusal by L2 tenderer, then to L3 tenderer & so on.
- c. In the event the company does not find the lowest quoted rate, acceptable to it, then the tender will be scrapped and may be re-invited, or company may take any other suitable action as deemed fit looking to the exigency of the work.

**14.0 NEGOTIATIONS:-**

- a. Negotiations may be conducted with the lowest tenderer only. In case of non-satisfactory achievement of rates from lowest tenderer, RSMML may choose to make a written counter offer to the lowest tenderer and if this is not accepted, RSMML may decide to reject and re-invite fresh tenders or to make the same counter-offer first to the second lowest tenderer, then to the third lowest tenderer and so on in the order of initial bidding, and work order be awarded to the tenderer who accepts the counter offer.
- b. In the case, when the quotations given by the tenderer during negotiations is higher than the original quotation of the tenderer then the tenderer will be bound by the lower rate originally quoted by the tenderer.
- c. In case of negotiations, representative of the tenderer attending negotiations must possess written authority from the tenderer to the effect that he is competent to modify/amend the submitted tender deviations and rates offered by them.
- d. In the event the company does not find the lowest quoted rate, acceptable to it, then the tender will be scrapped and may be re-invited, or company may take any other suitable action as deemed fit looking to the exigency of the work.

**15.0 NO COMPENSATION FOR ALTERATION OF DELIVERY SCHEDULE OR SUSPENSION OF SUPPLIES:**

If at any time before the commencement of the supply the Company, for any reason, whatsoever do not require the whole supply or part thereof as specified in the schedule of supplies, shall give notice in writing of the same to the supplier and the supplier shall neither be entitled to any compensation and/or damage of any kind whatsoever on account for loss or profit etc. nor the supplier be entitled to any claim or compensation for re-scheduling of delivery period.

**16.0 INSPECTION:**

- a. The pre dispatch inspection and test may be conducted at the premises of the tenderer. The tenderer will inform the RSMML well before in time for conducting pre dispatch inspection. However, the final inspection shall be carried out at consignee's end after receipt of the material at site which will be final and binding to both parties.'
- b. RSMML's right to inspect, test and, where necessary, reject the items after the arrival at RSMML site shall in no way be limited or waived by reason of the items having previously been inspected, tested and passed by the RSMML or its representatives prior to the goods.
- c. RSMML at its sole discretion may conduct third party inspection of supplied material after arrival of material at RSMML site and before final acceptance. The cost of such inspection will be borne by RSMML. In case Material are not found meeting the tender /order specifications in third party inspection, supplier will replace the material at their cost irrespective of the fact that the



material was earlier found acceptable during Pre -Dispatch Inspection by RSMML.

- d. In case of rejection of any supply, the same should be replaced immediately within 30 days of intimation for rejection. Tenderer will take rejected material back at his own risk, cost and transportation.

#### **17.0 PRICE:**

- a. The firm & fixed price should be quoted on-line in Indian Currency strictly in Price Bid (BOQ) Cover – C on f.o.r. destination basis.
- b. Tenderer (s) should offer prices strictly in the BOQ uploaded on the site. They should first download the BOQ from the site on their system and after filling it, the same BOQ should be uploaded on the e-procurement portal.
- c. Price will remain firm and fixed till the complete execution of the contract.
- d. Please quote the duties and taxes as applicable on the date of submission of offer clearly and separately against each item. In the event of any increase/decrease in the Taxes & duties by the Government, the difference of the same shall be passed on to the tenderer/RSMML as the case may be. The increase shall be payable only on the production of authentic documentary proof by the tenderer.
- e. Save and except as aforesaid, the tenderer shall not be entitled to raise any claim and/or demand and/or any dispute on account of escalation or raise or increase in the prices of any other item or element.
- f. Timely deposition of GST and filing of requisite tax returns of relevant tax period would be the sole responsibility of the contractor. The contractor will also ensure that necessary credit on this account is available to RSMML in the next month. In case of any discrepancy, where credit is not available to RSMML, then company is free to deduct/recover/retain such amount from the bills of contractor or any other amount due to him/or from security deposit, as the case may be.
- g. In case of reversal of Input tax credit (ITC), imposition of penalty on account of payment of GST and default in filing of returns towards the payment for the work, contractor is liable to pay all such dues to the company, failing which RSMML is free to deduct/recover/retain such amount from the bills of contractor or any other amount due to him/or from security deposit, as the case may be.
- h. Further, the contractor shall submit an undertaking with monthly bills bearing GSTIN and HSN/SAC Code that “total GST has been deposited and returns have been filed relevant tax period”.
- i. In addition, a general undertaking shall also be furnished by the bidder at the time of submission of bid that as on date, no default has been made by us towards payment of GST and all returns up to the last date of submission of bid have been filed by us.”

#### **18.0 PRICE VARIATION:**

- a. The quoted price should remain firm and fixed till the completion of supplies. Only variation on account of changes in Taxes & Duties by the Government will be considered. No escalation/ variation on any other grounds whatsoever shall be considered or be admissible:
- b. Escalation on Government Taxes & Duties: The tenderer will indicate in his offer the applicable Taxes & Royalty at the time of opening of Part-I offer. In the event of any increase/decrease in the Taxes & royalty by the Government, the difference of the same shall be passed on to the Contractor/RSMML as the case may be. The subsequent increase/decrease shall be payable only on the production of authentic documentary proof by the Contractor.
- c. Save and except as aforesaid, the contractor shall not be entitled to raise any claim and/or demand and/or any dispute on account of escalation or raise or increase in the prices of any other item or element whether in respect of electrical charges, high speed diesel, oil, lubricants, tyres, tubes, spares, wages or minimum wages of workmen either statutory or contractual under any settlement or award or otherwise or on any other ground/or reason whatsoever.

#### **19.0 PRICE FALL CLAUSE:**

In the event of supplier accepting lower prices for supplies covered under the contract to any other companies during the pendency of the contract, the lower price and charges will also be applicable to this contract. The supplier must intimate RSMML

as soon as they accept lower prices from any other company including PSU and Government Organization.

**20.0 CONSIGNEE:**

The Dy. General Manager [MM], SBU-PC (RP)  
or his authorized officer.  
RSMM Ltd, Jhamarkotra, Distt & via- Udaipur

**21.0 TERMS OF PAYMENT:**

- a. 100% payment within 30 days from date of taking over the system as per complete scope of work of tender.
- b. Billing & Paying Authority: The bill in triplicate along-with the supporting documents duly verified by the consignee will be released by Payment disbursing authority – The Payment disbursing authority is Sr. Manager (F&A), RSMML, Jhamarkotra, Udaipur.
- c. Payment will be made through RTGS/NEFT.
- d. Under the GST regime, section 51 of the CGST act,2017 and notification no. 50/2018- Central Tax dated 13th Sep 2018; the mandate TDS on GST shall be deducted at the rate of 2% from the payment made or credited to the supplier of taxable goods or services or both , where the total value of such supply, under the contract , exceeds two lakh and fifty thousand rupees [excluding GST].

**22.0 COMPENSATION FOR DELAYED DELIVERY:** In case the supplier fails to deliver the stores as per agreed specifications in full/part within the delivery date or the stores are rejected, the Company shall be entitled at its option:

- a. to recover from the supplier as agreed pre-determined compensation @ ½ % per week of the value of the undelivered stores, for each Week or part thereof subject to a maximum of 5% of value of undelivered store.
- b. either to purchase from elsewhere, without notice to supplier at his risk and cost for full or undelivered part, as the case may be.  
or
- c. to cancel the contract.

In case of (b & c) above, the company will be empowered to purchase stores which are readily available with alternative source to meet his requirement, irrespective of the fact whether these are similar or not.

**23.0 INDEMNIFICATION:**

Except where arising from the negligence of RSMML or RSMML's employees, the supplier shall indemnify RSMML in respect of any costs or damages, whatsoever arising out of or related to breach of statutes, laws, acts, rules and regulations, damage, accident or loss etc. by the supplier or suppliers personnel or by claims made against RSMML by third parties in respect thereof.

**24.0 RSMML's RIGHT:** RSMML reserves to exercise following rights at its sole discretion without assigning any reason thereof. The decision of the Company in these regards shall be final and binding.

- a. not to accept any offer or reject any or all the offers.
- b. to reject any or all the tenders received or accept a tender either for the total scope of work or part thereof & not to accept the lowest tender without assigning any reason.
- c. to cancel the tender, postpone it for another date, change the venue of the receipt/opening of the tender.
- d. to split/divide the quantity into more than one tenderer.
- e. to increase/ decrease the quantity.
- f. to accept/reject offered products on technical grounds
- g. to reject the offer, if it is established that the tenderer has submitted any wrong & misleading information/forged document along with offer and thereafter.

**25.0 TERMINATION:**

- a. In case of failure to perform the job as required under this tender or observe breach of any of the terms and conditions by the tenderer, the company shall give

- a notice to rectify such default/breach with 10 days, failure to which may result in termination of the contract and forfeiture of security deposit without any prejudice to the Company's rights to claim damages/ cost/ loss etc caused by such default/ breach. Such termination shall not absolve the supplier of the liabilities accruing till the date of such termination.
- b. The contract may also be terminated in the event the supplier is being adjudged insolvent or going into Liquidation or Winding up of their business or making arrangement with their creditors.
- c. Notwithstanding anything contained herein above, the Company in its absolute discretion may at any time terminate the order without assigning any reason thereof by giving fifteen day's notice to the supplier at their last notified address. In such an event the supplier shall not be entitled to raise any claim or demand for compensation, loss of profit and/or damages and/ or losses or costs by reason of such earlier termination on any ground whatsoever.

**26.0 FORCE MAJEURE:**

At any time, during the continuance of the contract, the performance in whole or in part by either party (sub-vendors excluded) and/ or obligations under this contract shall be prevented or delayed by reason of any war, Hostility acts of public enemy, civil commotion, sabotage, fires, floods, explosion, epidemics, quarantine restrictions, non-performance due to Acts of God or Acts of Government /statutory bodies (herein after referred as "Event") then provided a notice of the happening of any such event is given within seven days from the date of occurrence thereof neither party shall by reason of such event be entitled to terminate this contract nor shall either party have any claim for damage against the other in respect of such non-performance or delay in performance and the deliveries and/or performance of the work under the contract shall be resumed as soon as practicable after such event has come to an end or ceased to exist and decision of Company as to whether the deliveries and/or performance of the work have been so resumed or not shall be final and conclusive. Provided further that if the performance in whole or in part is delayed by reasons of any such events for a period exceeding thirty days either party may at its option terminate the contract.

**27.0 JURISDICTION:**

The Law of the land will prevail and legal jurisdiction shall be the exclusive Courts situated in Udaipur in the State of Rajasthan only.

For RAJASTHAN STATE MINES & MINERALS LIMITED

**(Satish Kachhawa),  
Dy. GENERAL MANAGER (MM)**

I / We have studied the above terms and conditions and having understood the same in true sense and spirit, I/We shall abide by and adhere to the above terms and conditions fully.

Signature and Seal of the Tenderer

Place :  
Date :

**ACCEPTANCE TO THE TECHNICAL SPECIFICATION**

(To be enclosed with part-I of offer)

<b>Sr. No.</b>	<b>Item Description</b>	<b>Unit</b>	<b>Qty</b>	<b>Deviation (If any)</b>
1	Frame Toggle Seat Part No. 2-323-A-9 [For <u>Mcnally Bharat</u> Make Jaw Crusher Model 42"X48", OHE, Sr. no. 88-I-11 Cap / Rating : 160 TPH]	Nos.	1	
2	Spring Coil Part no. SS-16 VS 133 [For <u>Radiant</u> make D D Vibrating Screen II model SS-16 Cap/Rating : 8'X20'] As per enclosed Drawing No. - RSMM/IBP-LGO/SHII-VS-133 Dt. 26-04-2003 1 Set = 12 Springs	Nos.	12	
3	Wheel assembly set complete with Shaft, Bush, Key & Lock Plate for <u>CIMMCO</u> make Rack Car of Reclaimer (As per Drg. - D361 A1 DD M 52-04-03 Encl.) Set consisting of <b>Assemble Part List</b> 1. Wheel MOC - Cast Steel - 1 no. 2. Cover Plate MOC M. S. - 2 Nos. 3. Shaft EN 8 - 1 no 4. H. T. Hex Bolt M16 X 2 X 50 MM - 6 Nos. 5. Bush MOC M S - 1 No. 6. Key MOC MS - 1 No.	Set	4	
4	Vortex finder cap NI (75 X 50 inlet cross section for 100 MM insert / out let) Part No. C - 650	Nos.	3	
5	Cone, Cyclone M.S for wet screen Part No. C - 650 (Drg. No. IBP/MPP/V.D/160/2012)	Nos.	6	
6	Cone, Liner NR Part No. C - 650 (P. No. C - 652 U)	Nos.	6	
7	Housing Apex M. S for wet screen cyclone Part No. C - 650 (Drg. No. IBP/MPP/Mech./MK/162/2012)	Nos.	6	
8	Nipple for Vortex finder Cap Part No. C - 630 (Drg. No. IBP/MPP/Cyl./172/2012)	Nos.	6	
9	Cone liner Lower body PU hydrocyclone C - 630 Part No. C - 633	Nos.	10	
10	Vortex finder Cap PU (53 X 20 inlet cross section for 45 MM insert) Part No. C - 630	Nos.	12	
11	Inlet Head Liner 2.2 Sq. Inch Gum Rubber for D - 6 Hydrocyclone (Secondary Cyclone) Part No. 62 - R - RG - 2.2	Nos.	5	
12	Top Cover Plate Liner Gum Rubber for D - 6 Hydrocyclone (Secondary Cyclone), Part No. 63 R - RG	Nos.	5	
13	Over flow assembly for D - 6 Hydrocyclone (Drg. No. IBP/MPP/MECH/VD/185/2013)	Nos.	3	
14	Apex Housing for D - 6 Hydrocyclone (Drg. No. IBP/MPP/SEC. CYCL/APEX HSG./222-2020)	Nos.	8	
15	SS 316 Stud with 2 Nos. Washer & 2 Nos Nut (SS316) M 16 X 12" (Drawing No. IBP - MPP - MECH. - MK - 149 / 2012)	Nos.	30	
16	Ball Valve for Diaphragm Pump (Weight 10 Kg) Part No. 09 [Pump Model : VM6]	Nos.	10	

**Special Note:**

- Interested bidder may visit our site if they desire to ensure actual dimensions. Supplier should also confirm fitment guarantee i.e. proper fitment of items in our assembly.
- If, there is any deviation it should be specifically mentioned for proper evaluation of offer.

We hereby confirm and accept to supply of material as per above specifications.

Signature of Tenderer with official stamps

Date &amp; Place

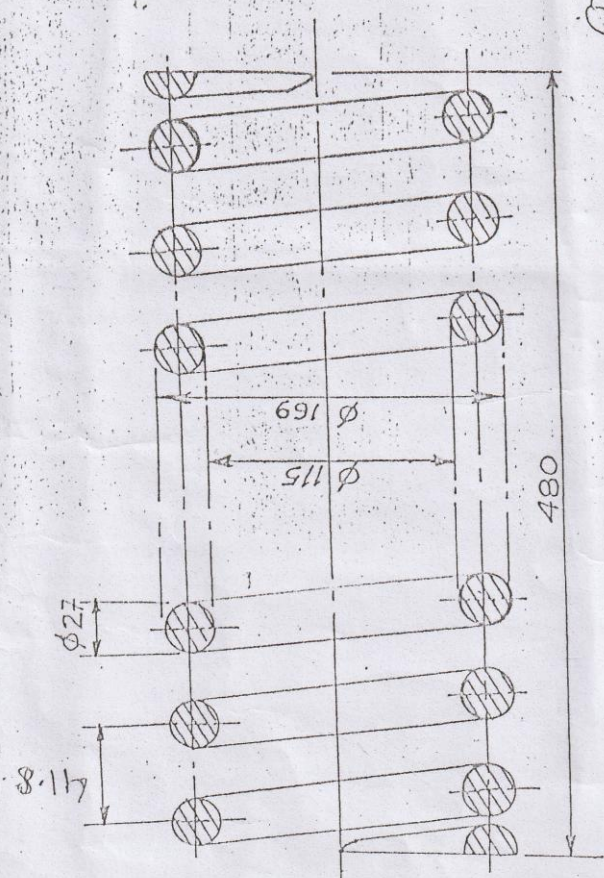

NUMBER OF COILS = 92  
 MATERIAL :- Spring steel.  
 Pat no. VS-133

DRAWING No. ①

RAJASTHAN STATE MINES & MINERALS LTD.  
 JHAMARKOTRA, UDAIPUR.

SCALE :-	N.T.S	DRG. NO. RSM/IBP-LGO/SH-III/2
DRAWN	26.4.03	SPRING FOR VIBRATING SCREEN II <sup>ND</sup>
CHECKED		
APPROVED		

*(Signature)*  
 (Name)

159-1



R/56-1

(2)

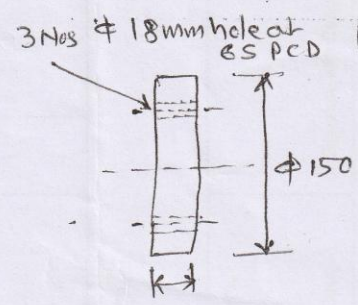
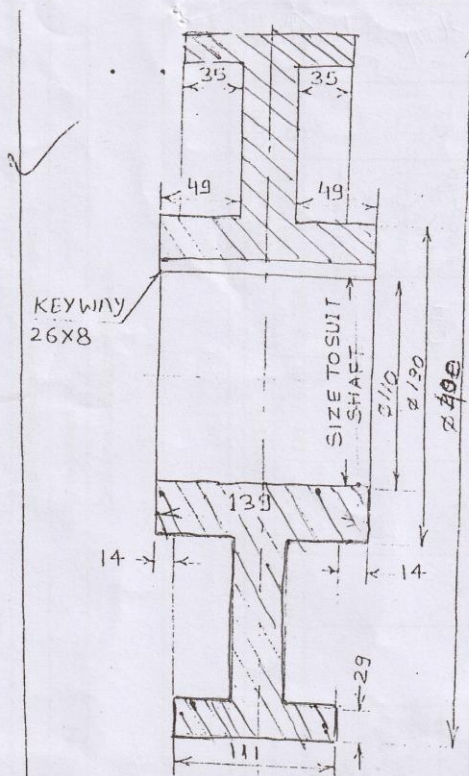

Cover plate - 2 No  
MAT - M.S.

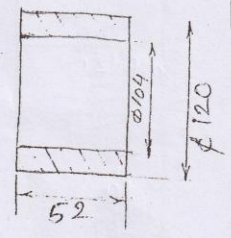

BUSH - IND  
MAT - EN 8

WHEEL - IND  
MOC - CAST STEEL  
IS 2707 (Latest)

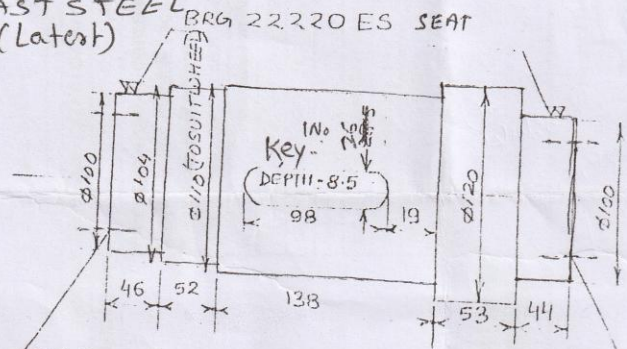

46  
52  
138  
53  
44  
= 333

3 NOS TAPE  
HOLE M-16  
AT Ø 65 PCD

SHAFT - IND

3 NOS TAPE  
HOLE M-16  
AT Ø 65 PCD

R/C RAKE CAR WHEEL

ALL DIA ARE IN MM

ASSY

SCALE - NTS

PART NO - D361A1-DD-M52-04-03

1) MAT -

DRAWING NO - 1

SRC-W001

2) MAT - SHAF1 -

*[Signature]*  
11/01/2020

13

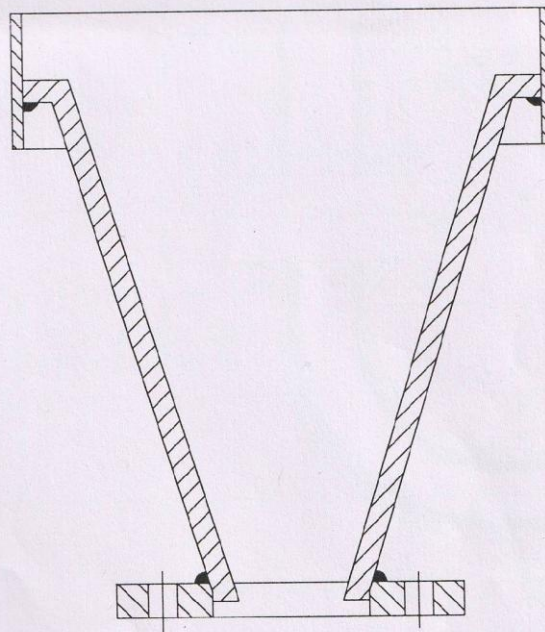
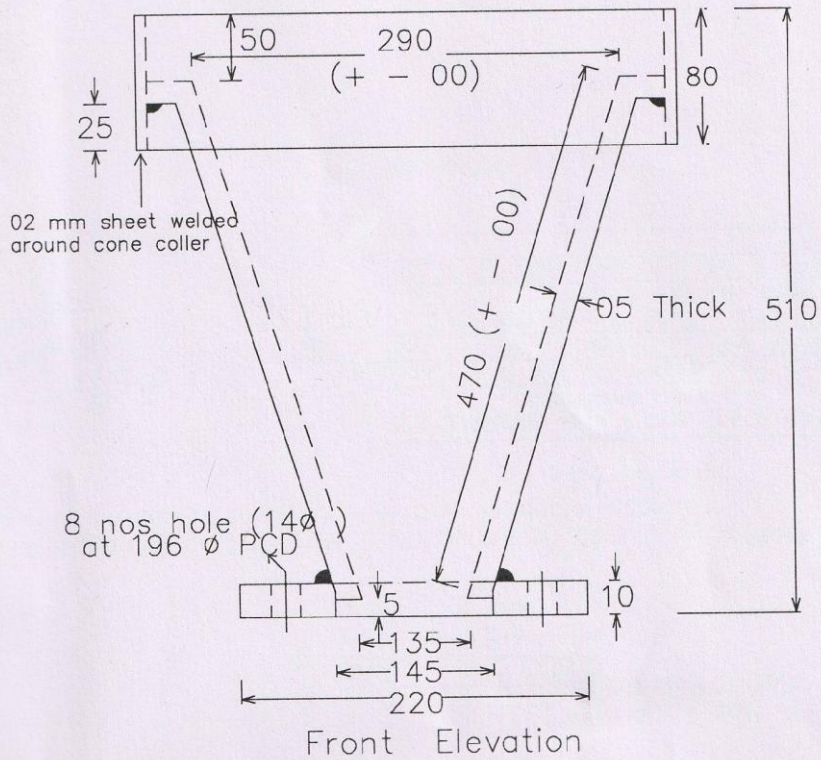

*Dino*  
24.10.20  
mgc

	RAJASTHAN STATE MINES AND MINERALS LTD. ( A GOVT. OF RAJ. ENTERPRISE )
NAME	-Wet Screen M.S. cone
DRG NO.	-JBP / MPP / Mech. / MK / cyclone / 160
MATERIAL	- Mild Steel
DIMENSIONS ARE IN MM AND DRG. NOT TO SCALE	
REMARKS	-Cone dimension tolerance must be + -



Wet Screen Cyclone Apex housing

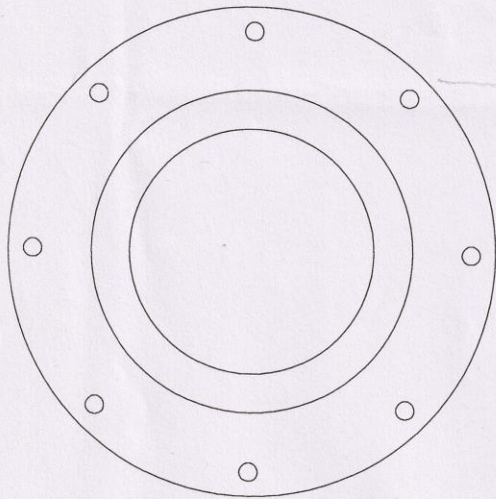

Plan

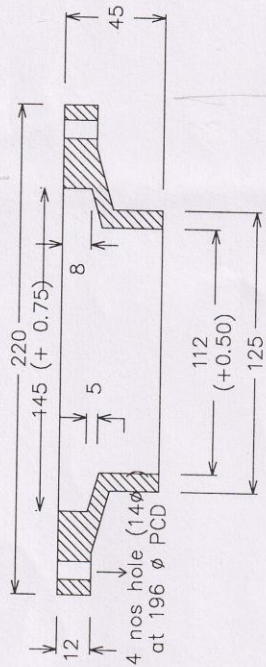

Sectional Elevation

*Handwritten signature and date: 21/10/2012*

*Handwritten number: 155-3*

	RAJASTHAN STATE MINES AND MINERALS LTD. ( A GOVT. OF RAJ. ENTERPRISE )
NAME	Wet Screen Cyclone Apex Housing
DRG NO.	4BP / MPP / Mech. / MK / Cyclone
MATERIAL	Mild Steel
DIMENSIONS ARE IN MM AND DRG. NOT TO SCALE	
REMARKS -	

/ 162 / 2012



Heavy duty seam less pipe with Rubber lining

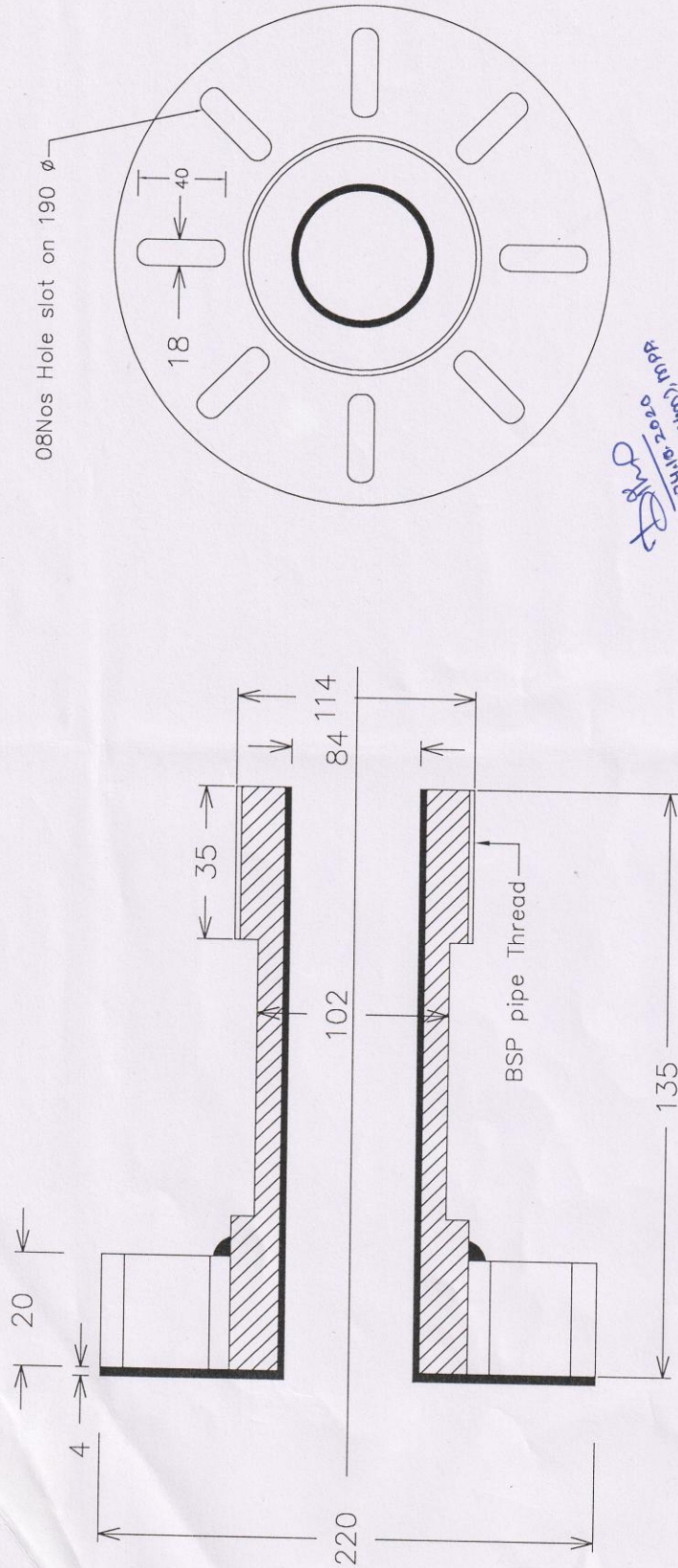

NOTE:- Rubber lining shall be hot rubber lined.

	RAJASTHAN STATE MINES AND MINERALS LTD. ( A GOVT. OF RAJ. ENTERPRISE )
NAME	Cyclone vortex Nipple
DRG NO.	IBP / MPP / Mech. / M.K / 172 / 2012
MATERIAL	Heavy duty seam less pipe with Rubber lining
DIMENSIONS	ARE IN MM AND DRG. NOT TO SCALE
REMARKS	Nipple inside flange should be welded from both inside and outside.

255-2

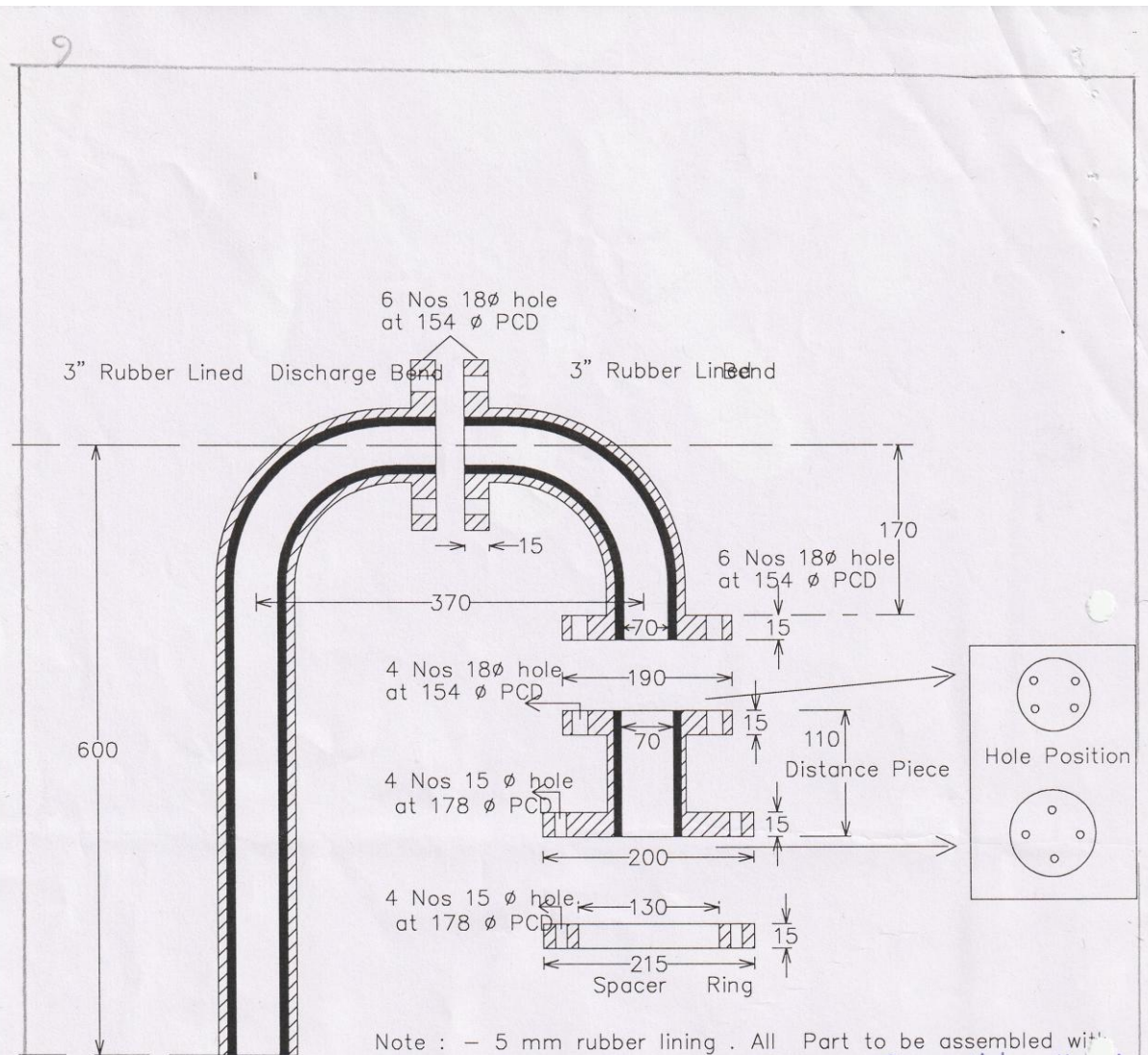

Note : - 5 mm rubber lining . All Part to be assembled with necessary gasket and M.S Fasteners. Rubber lining should be hot type.

	RAJASTHAN STATE MINES AND MINERALS LTD. ( A GOVT. OF RAJ. ENTERPRISE )
NAME - Over flow assembly for D 6 Cyclone	
DRG NO. -IBP / MPP / Mech. / V.D / 185 / 2013	
MATERIAL - M.S ERW Pipe ( wall thickness 5mm ) and 5 mm Rubber Lining	
DIMENSIONS ARE IN MM AND DRG. NOT TO SCALE	
REMARKS -	

*Signature*  
24.10.2020  
MPP (Mech), MPP

Checked By

Prepared By

*Handwritten initials*



01

### Apex Housing D - 6

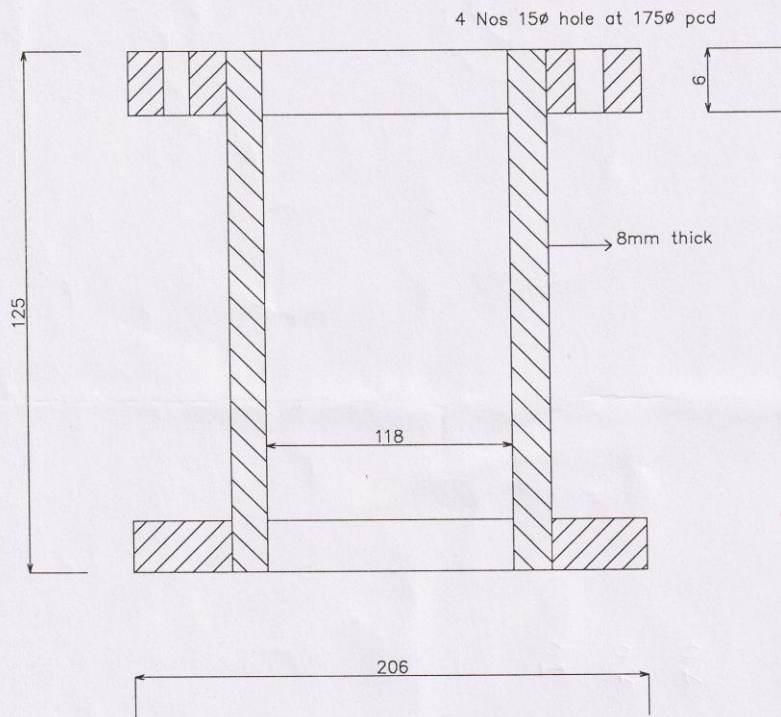

*Signature*  
24.10.2020  
Mg(M), MPP

g. No. IBP/ MPP/ Sec. cycl./ Apex Hsg/222-2020

1-55/4

# S. S. STUD WITH WASHER AND NUTS.

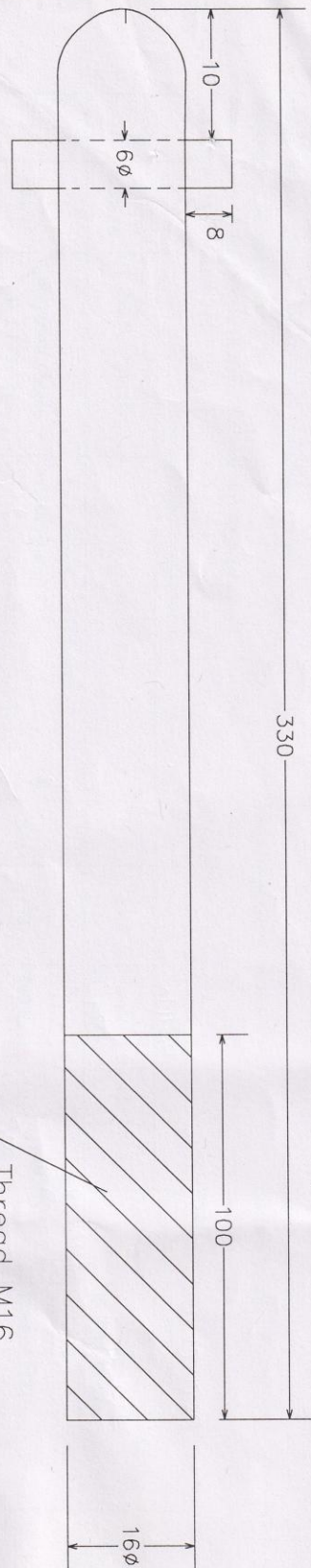

Note : 1. Nut Size M 16 Qty. 02 Nos  
and washer thickness 3 mm qty. 02 Nos

2. MOC of stud , nut , Washer, pin shall be SS 316

 <b>RAJASTHAN STATE MINES AND MINERALS LTD.</b> ( A GOVT. OF RAJ. ENTERPRISE )	
NAME	S.-S. stud with washer and M16 nuts.
DRG NO. IBP / MPP / MECH / MK / 149 / 2012	
MATERIAL STAINLESS	STEEL316
DIMENSIONS ARE IN MM AND DRG. NOT TO SCALE	
REMARKS stud should be fitted with one washer & 2NO. nuts.	

*Handwritten signature and date:*  
 24/10/2020  
 Meghm, MPP

*Handwritten number:*  
 P/S-1

**GENERAL PROFILE OF TENDERER**(To be submitted with PART – I Technical Bid)

1	Name & address of the tenderer with				
	Telephone No.,				
	Fax No.				
	e-mail address etc.				
	Mobile No.				
2	Date of establishment.				
3	Whether Proprietor/Partnership/ Company				
4	Name of Owner/Partners/ Directors with full address.				
5	Work Completion period for complete scope of work under tender				
6	Annual turnovers in rupees for last three years.	2019-20	2018-19	2017-18	
7	PAN No.				
8	GST No.				
9	Entrepreneurs memorandum no. as per MSMED Act 2006 Nature of Activity (manufacturing/Service) Category of Enterprise: (Micro/ Small/ Medium )				
10	Banker details: • Name • Branch No. • Address				
11	Bank Account No.				
12	Type of A/c : Saving / Current/CC/ any other				
13	IFSC code				
14	Any other important information related to the tender requirement.				

Signature of tenderer with official stamp

Date &amp; Place:

**UNDERTAKING TOWARDS ACCEPTANCE OF ALL TERMS & CONDITIONS OF TENDER**

Name of Tenderer\_\_\_\_\_

**We confirm that all the terms & conditions of tender is acceptable to us except the following.**

Tenderer may stipulate here exceptions and deviations to the tender conditions, if considered unavoidable. In case the tenderer does not mention any information to the deviations in the below format & furnish it blank then it will be presumed that the tenderer is not offering/ putting any deviations to the tender terms & condition. Tenderer should mention the deviations, if any, at their own risk of rejection of their offer.

Sl. No.	Tender Clause no.	Requirement as per tender clause	Offered condition/ Deviation

Company may accept or not to accept the deviations put by the tenderer at its sole discretions. No claim on this will be entertained.

Note: Deviation to the tender terms, if any, mentioned any where else (i.e. in any other document will not be considered & accepted. RSMML will not entertain any claim of the tenderer on offered deviations mentioned anywhere else.

Signature of tenderer with official stamp

Date:  
Place:

**UNDERTAKING TOWARDS NON-SUSPENSION/NON-BANNING / GST.**

Name of the Tenderer: \_\_\_\_\_

We hereby declare that we have not been banned/suspended or de-listed by RSMML in past.

We undertake that "as on date, no default has been made by us towards payment of GST and all returns up to the last date of submission of bid have been filed by us."

Signature of Tenderer with official stamp

Place:

Date:

**Declaration for Registration under Micro, Small & Medium Enterprises Development Act, 2006.**

- I. Whether the tenderer is registered under Micro, Small & Medium Enterprises Development Act, 2006. \_\_\_\_\_(Yes/NO)
- II. If yes, please furnish the declaration given below.
- III. We (Name of tenderer\_\_\_\_\_), hereby declare that, our organization is registered under Micro, Small & Medium Enterprises Development Act, 2006 as \_\_\_\_\_ (Micro, Small & Medium) Enterprises having entrepreneurs Memorandum no. .... and under category of .....( Manufacturer /Service).
- IV. Enclose attested copy of registration certificate.

Signature of tenderer with official stamp

Date:  
Place:



**DETAILS OF TAXES & DUTIES OFFERED IN PRICE BID**

Name of Tenderer \_\_\_\_\_

<b>Particulars</b>	<b>% Rate considered in price bid</b>
Price Basis	F.O.R. JHAMARKOTRA, UDAIPUR
Freight Charges	@.....%
P & F Charges	@.....%
CGST	@.....%
RGST	@.....%
IGST	@.....%
GST on any other component	
i) Freight, Insurance	@.....%
ii) Any other charges	@.....%
Delivery Period	.....

Signature of tenderer with official stamp

Date:  
Place:

## Annexure-VII

### DETAILS OF PAST EXPERIENCE

{To be submitted with Part-1 of the offer (Techno- commercial part)}

List of order(s) executed towards supply of similar type of material.

<b>Sr. No.</b>	<b>Name &amp; Address of the Purchaser</b>	<b>Order no. &amp; Date</b>	<b>Brief Description</b>	<b>Value of Work</b>
01				
02				
03				
04				

Signature of tenderer with official stamp

Date:

Place:

Enclose: Supporting Document towards tenderer status, as above.

**DECLARATION BY TENDERER**

I/We declare that I am/ We are /manufacturer/ distributor/Authorised dealer/ bonafide dealers in the goods/stores/equipments for which I/We have tendered.

If this declaration is found to be incorrect then without prejudice to any other action that may be taken, my/our bid security/security deposit may be forfeited in full and the tender if any to the extent accepted may be cancelled.

Signature of tenderer with official stamp

Date:

Place:

Enclose: Supporting Document towards tenderer status, as above

## **ANNEXURE-A**

### **Compliance with the Code of Integrity and No Conflict of Interest**

(To be submitted - part – I of the offer)

Any person participating in a procurement process shall –

- a) Not offer any bribe, reward or gift or any material benefit either directly or indirectly in exchange for an unfair advantage in procurement process or to otherwise influence the procurement process;
- b) Not misrepresent or omit that misleads or attempts to mislead so as to obtain a financial or other benefit or avoid an obligation;
- c) Not indulge in any collusion, Bid rigging or anti-competitive behaviour to impair the transparency, fairness and progress of the procurement process;
- d) Not misuse any information shared between the procuring Entity and the Bidders with an intent to gain unfair advantage in the procurement process;
- e) Not indulge in any coercion including impairing or harming or threatening to do the same, directly or indirectly, to any party or to its property to influence the procurement process;
- f) Not obstruct any investigation or audit of a procurement process;
- g) Disclose conflict of interest, if any, and
- h) Disclose any previous transgressions with any Entity in India or any other country during the last three years or any debarment by any other procuring entity.

#### **Conflict of Interest:-**

The Bidder participating in a bidding process must not have a Conflict of Interest.

A Conflict of Interest is considered to be a situation in which a party has interests that could improperly influence that party's performance of official duties or responsibilities, contractual obligations, or compliance with applicable laws and regulations.

- i) A Bidder may be considered to be in Conflict of Interest with one or more parties in a bidding process if, including but not limited to:
  - a) Have controlling partners/shareholders in common; or
  - b) Receive or have received any direct or indirect subsidy from any of them; or
  - c) Have the same legal representative for purposes of the bid; or
  - d) Have a relationship with each other, directly or through common third parties, that puts them in a position to have access to information about or influence on the bid of another Bidder, or influence the decisions of the Procuring Entity regarding the bidding process; or
  - e) The Bidder participates in more than one bid in a bidding process. Participation by a Bidder in more than one bid will result in the disqualification of all bids in which the Bidder is involved. However, this does not limit the inclusion of the same subcontractor, not otherwise participating as a Bidder, in more than one bid; or
  - f) The Bidder or any of its affiliates participated as a consultant in the preparation of the design or technical specifications of the Goods, Works or Services that are the subject of the bid; or
  - g) Bidder or any of its affiliates has been hired (or is proposed to be hired) by the Procuring Entity as engineer-in-charge/consultant for the contract.

**Declaration by the Bidder regarding qualifications Declaration by the Bidder**  
(To be submitted - part – I of the offer)

In relation to my/our Bid submitted to .....for procurement of .....in response to their Notice Inviting Bids No..... dated .....I/we hereby declare under Section 7 of Rajasthan Transparency in Public Procurement Act 2012, that :

1. I/we possess the necessary professional, technical, financial and managerial resources and competence required by the Bidding Document issued by the Procuring Entity;
2. I/we have fulfilled my/our obligation to pay such of the taxes payable to the Union and the State Government or any local authority as specified in the Bidding Document;
3. I/we are not insolvent, in receivership, bankrupt or being wound up, not have my/our affairs administered by a court or a judicial officer, not have my/our business activities suspended and not the subject of legal proceedings for any of the foregoing reasons;
4. I/we do not have, and our directors and officers not have been convicted of any criminal offence related to my/our professional conduct or the making of false statements or misrepresentations as to my/our qualifications to enter into a procurement contract within a period of three years preceding the commencement of this procurement process, or not have been otherwise disqualified pursuant to debarment proceedings;
5. I/we do not have a conflict of interest as specified in the Act, Rules and the Bidding Document, which materially affects fair competition;

Date:

Signature of bidder

Place:

Name:

Designation:

Address:

**Grievance Redress during Procurement Process**

(To be submitted - part – I of the offer)

The designation and address of the First Appellate Authority is: Mines Dept, GOR

The designation and address of the Second Appellate Authority is: Finance Dept., GOR

1. **Filing an appeal** : If any Bidder or prospective bidder is aggrieved that any decision, action or omission of the Procuring Entity is in contravention to the provisions of the Act or the Rules or the Guidelines issued there under, he may file an appeal to First Appellate Authority, as specified in the Bidding Document within a period of ten days from the date of such decision or action, omission, as the case may be clearly giving the specific ground or grounds on which he feels aggrieved: Provided that after the declaration of a Bidder as successful the appeal may be filed only by a Bidder who has participated in the procurement proceedings: Provided further that in case a Procuring Entity evaluates the technical bids before the opening of the financial Bids, an appeal related to the matter of Financial Bids may be filed only by a Bidder whose Technical Bid is found to be acceptable.
2. The officer to whom an appeal is filed under para (1) shall deal with the appeal as expeditiously as possible and shall endeavor to dispose it of within thirty days from the date of the appeal.
3. If the officer designated under para (1) fails to dispose of the appeal filed within the period specified in para (2) or if the Bidder or prospective bidder or the Procuring Entity is aggrieved by the order passed by the First Appellate Authority, the bidder or prospective bidder or the Procuring Entity, as the case may be, may file a second appeal to Second Appellate Authority specified in the Bidding Document in this behalf within fifteen days from the expiry of the period specified in para (2) or of the date of receipt of the order passed by the First Appellate Authority, as the case may be.
4. **Appeal not to lie in certain cases** : No appeal shall lie against any decision of the Procuring Entity relating to the following matters, namely:-
  - a. Determination of need of procurement;
  - b. Provisions limiting participation of Bidders in the Bid process;
  - c. The decision of whether or not to enter into negotiations ;
  - d. Cancellation of a procurement process;
  - e. Applicability of the provisions of confidentiality.
5. **Form of Appeal**
  - a. An appeal under para (1) or (3) above shall be in the annexed form along-with as many copies as there are respondents in the appeal;
  - b. Every appeal shall be accompanied by an order appealed against, if any, affidavit verifying the facts stated in the appeal and proof of payment of fee.
  - c. Every appeal may be presented to First Appellate Authority or Second Appellate Authority, as the case may be, in person or through registered post or authorized representative.
6. **Fee for filing appeal**
  - a. Fee for the first appeal shall be rupees two thousand five hundred and for second appeal shall be rupees ten thousand, which shall be non-refundable.
  - b. The fee shall be paid in the form of bank demand draft or bankers' cheque of a Scheduled Bank in India payable in the name of Appellate Authority concerned.
7. **Procedure for disposal of appeal**
  - a. The First Appellate Authority or Second Appellate Authority, as the case may be, upon filing of appeal, shall issue notice accompanied by copy of appeal, affidavit and documents, if any, to the respondents and fix date of hearing.
  - b. On the date fixed for hearing, the First Appellate Authority or Second Appellate Authority , as the case may be, shall –
  - c. Hear all the parties to appeal present before him; and
  - d. Peruse or inspect documents, relevant records or copies thereof relating to the matter.
  - e. After hearing the parties, perusal or inspection of documents and relevant records or copies thereof relating to the matter, the Appellate Authority concerned shall pass an order in writing and provide the copy of order to the parties to appeal free of cost.
  - f. The order passed under sub-clause (c) above shall also be placed on the State Public Procurement Portal.

**(See rule 83)**

**Memorandum of Appeal under the Rajasthan Transparency in Public Procurement,  
Act 2012**

(To be submitted - part – I of the offer)

Appeal No..... of .....

Before the .....( First /Second Appellate Authority)

1. Particulars of appellant :

(i) Name of the appellant :

(ii) Official address, if any:

(iii) Residential address:

2. Name and address of the respondent(s) :

(i)

(ii)

(iii)

3. Number and date of the order appealed against and name and designation of the officer/authority who passed the order (enclose copy), or a statement of a decision, action or omission of the Procuring Entity in contravention to the provisions of the Act by which the appellant is aggrieved:

4. If the Appellant proposes to be represented by a representative, the name and postal address of the representative :

5. Number of affidavits and documents enclosed with the appeal :

6. Ground of appeal:.....  
.....  
.....  
.....(Supported by an affidavit)

7. Prayer:.....  
.....

Appellant's signature :

Place:

Date:

**Additional Conditions of Contract**

(To be submitted - part – I of the offer)

1. **Correction of arithmetical errors** : Provided that a Financial Bid is substantially responsive, the Procuring Entity will correct arithmetical errors during evaluation of Financial Bids on the following basis:
  - i) if there is a discrepancy between the unit price and the total price that is obtained by multiplying the unit price and quantity, the unit price shall prevail and the total price shall be corrected, unless in the opinion of the Procuring Entity there is an obvious misplacement of the decimal point in the unit price, in which case the total price as quoted shall govern and the unit price shall be corrected;
  - ii) If there is an error in a total corresponding to the addition or subtraction of sub totals, the subtotals shall prevail and the total shall be corrected; and
  - iii) If there is a discrepancy between words and figures, the amount in words shall prevail, unless the amount expressed in words is related to an arithmetic error, in which case the amount in figures shall prevail subject to (i) and (ii) above.If the Bidder that submitted the lowest evaluated bid does not accept the correction of errors, its bid shall be disqualified and its Bid Security shall be forfeited or its Bid Securing Declaration shall be executed.
  
2. **Procuring Entity's Right to Vary Quantities:** At the time of award of contract, the quantity of Goods, works or services originally specified in the Bidding Document may be increased or decreased by a specified percentage, but such increase or decrease shall not exceed twenty percent, of the quantity specified in the Bidding Document. It shall be without any change in the unit price or other terms and conditions of the bid and the conditions of contract. If the Procuring Entity does not procure any subject matter of procurement or procures less than the quantity in the Bidding Document due to change in circumstances, the bidder shall not be entitled for any claim or compensation except otherwise provided in the conditions of contract. In case of procurement of goods or services, additional quantity may be procured by placing a repeat order on the rates and conditions of the original order. However, the additional quantity shall not be more than 50% of the value of goods of the original contract and shall be within one month from the date of expiry of last supply. If the supplier fails to do so, Procuring Entity shall be free to arrange for the balance supply by limited bidding or otherwise and the extra cost incurred shall be recovered from the supplier.

Dividing quantities among more than one bidder at the time of award (In case of procurement of goods): As a general rule all the quantities of the subject matter of procurement shall be procured from the bidder, whose bid is accepted. However, when it is considered that the quantity of the subject matter of procurement to be procured is very large and it may not be in the capacity of the bidder, whose bid is accepted, to deliver the entire quantity or when it is considered that the subject matter of procurement to be procured is of critical and vital nature, in such cases, the quantity may be divided between the bidder, whose bid is accepted and the second lowest bidder or even more bidders in that order, in a fair, transparent and equitable manner at the rates of the bidder, whose bid is accepted.



(Apply in Duplicate)

**Application by MSME for Purchase Preference in Procurement of Goods**

To,  
The General Manager  
DIC, District .....

1. Name of Applicant with Post:
2. Permanent Address:
3. Contact Details:
  - a. Telephone No.:
  - b. Mobile No.:
  - c. Fax No.:
  - d. Email Address:
4. Name of micro & small enterprise:
5. Office Address:
6. Address of Work Place:
7. No. & Date of Entrepreneurs Memorandum-II/Udyog Aadhaar Memorandum: (enclose photo copy):
8. Products which Entrepreneurs Memorandum-II/Udyog Aadhaar Memorandum availed:
9. Products which are at present being produced by the enterprise:
10. Products for which purchase preference has been applied for:
11. Production capacity as per Capacity Assessment Certificate (enclose photocopy of Capacity Assessment Certificate):

Serial No.	Product	Product Production Capacity	
		Quantity	Value
1			
2			
3			
4			

12. List of Plant & Machinery installed:

Serial No.	Name of Plant & Machinery	Quantity	Value
1			
2			
3			
4			

13. List of Testing Equipment's installed:

Serial No.	Name of Testing Equipment's	Quantity	Value
1			
2			
3			
4			

14. Benefits availed in last financial year and current financial year: a. Benefits depositing Bid Security and Performance Security:

Last Financial Year			Current Financial Year	
Department	Bid Security	Performance Security	Bid Security	Performance Security

b. Details of Supply orders received:

Last Financial Year				Current Financial Year		
Department	No. & Date of purchase order	Amount for which purchase order received	Amount of goods supplied	No. & Date of purchase order	Amount for which purchase order received	Amount of goods supplied

I declare that the above all facts given in the application are correct and my enterprise is producing the items mentioned in column No. 10.

Date

Signature

(Name of the applicant along with seal of post)

Office of the District Industries Centre \_\_\_\_\_

**CERTIFICATE**

File No. \_\_\_\_\_

Date\_\_\_\_\_

It is certified that M/s \_\_\_\_\_was inspected by \_\_\_\_\_on dated \_\_\_\_\_ and the facts mentioned by the enterprise are correct as per the record shown by the applicant. The enterprise is eligible for Purchase Preference under this notification.

The certificate is valid for one year from the date of its issue.

Office Seal Signature

(Full Name of the Officer)

General Manager

District Industries Centre

Rubber Seal/Stamp

Enclosure-

(1) Application

(2)

(3)

**Format of Affidavit**

I \_\_\_\_\_ S/o \_\_\_\_\_ Aged \_\_\_\_\_ Yrs \_\_\_\_\_

\_\_\_\_\_

residing \_\_\_\_\_ at \_\_\_\_\_

Proprietor/Partner/Director of M/s \_\_\_\_\_ do

hereby solemnly affirm and declare that:

a. My/Our above noted enterprise M/s \_\_\_\_\_ has been issued acknowledgment of Entrepreneurial Memorandum Part - II by the District Industries Center ..... The acknowledgement No. is ..... dated ..... and has been issued for manufacture of following items

Name of Item	Production Capacity (Yearly)
--------------	------------------------------

- (i)
- (ii)
- (iii)
- (iv)
- (v)

b. My/Our above noted acknowledgement of Entrepreneurial Memorandum Part - II has not been cancelled or withdrawn by the Industries Department and that the enterprise is regularly manufacturing the above items.

c. My/Our enterprise is having all the requisite plant and machinery and is fully equipped to manufacture the above noted items.

Place \_\_\_\_\_

Signature of Proprietor/ Director Authorized Signatory

with Rubber Stamp and date